

BUILDING LANGUAGE: WORD MEANINGS

A manual of language exercises
for adults and adolescents

Robyn Dower

B.App.Sci. (Speech Pathology)

and

Jan Mackey

B.App.Sci. (Speech Pathology)

M.A. (Applied Linguistics)

Illustrations by
Omiros Tsorbatzoglou

Helios Art and Book Co.
95 Gilles Street
Adelaide
South Australia 5000

Telephone: (08) 232 0833
Facsimile: (08) 223 7711

Copyright © April 1996 by R. Dower and J. Mackey

Illustrated by: Omiros Tsorbatzoglou
Edited by: Andrew Booth
Pre-press coordination: Andrew Davies
Reformatting/Typesetting: Ian Goss
Printed by: Graphic Print Group

National Library of Australia
Cataloguing-in-Publication entry:

Dower, Robyn

Building language : word meanings ; a manual
of language exercises for adults and adolescents.

Bibliography. .

ISBN 1 875852 10 7

1. English language - Composition and exercises - Study and teaching
2. English language - Spoken language
3. Language disorders
4. Vocabulary - Study and teaching
5. Speech therapy

- I. Mackey, Jan
- II. Tsorbatzoglou, Omiros
- III. Title

428.8107

Copyright © 1996, Helios Art and Book Co.

All rights reserved. Permission is granted for the purchaser or their agent to photocopy and to make duplicating masters of pages in limited form for direct treatment use. No other parts may be reproduced or transmitted, in any form or by any means, electronic or mechanical, including photocopying and recording, or by any information storage and retrieval system, without written permission from the publisher.

Acknowledgements

Our thanks to several people who have assisted in the production of this book:

Chris Mackey for technical advice and many hours of hands-on assistance.

Marjory Dower for her months of persistent support.

Dennis Trehella for helpful suggestions and encouragement.

Chris Scott for constructive feedback, advice and enthusiastic support.

Ruth Irving for willing advice on the use of this book from an adult literacy perspective.

Dr Carmel Lum for her generous support and interest.

Professor Max Coltheart for reassurance of the need for such a book.

Our colleagues at the Royal Talbot Rehabilitation Centre and the Austin and Repatriation Medical Centre for their interest and encouragement.

Special thanks to **Andrew Booth** for his committed and thorough editing, and to **Andrew Davies, Ian Goss** and the **Helios team** for their attention to the detail of production.

TABLE OF CONTENTS



Introduction

Who can use this workbook?.....	3
Why another language workbook?	4
How to use this book: notes for the helper.....	5
How are the exercises structured?.....	7
Grading of tasks	8
Glossary of picture vocabulary used in sections 2, 3 & 4	9



Picture Meanings

Goals and Instructions	13
Level A - Input - Which is the odd one?	14
Level B - Input - Which is the odd one?	24



Spoken Word - Picture Links

Goals and Instructions	37
Level A - Input - Point to the one I say	38
Level B - Input - Point to the one I say	46
Level C - Input - Point to the one I say	62



Written Word - Picture Links

Goals and Instructions	79
Level A - Input - Match the word to its picture	80
Level B - Input - Match the word to its picture	84
Level C - Input - Match the word to its picture	88



Words in Groups

Goals and Instructions	107
Level A - Input	
- What belongs in this group?.....	108
- Match each word with its group	112
- What are parts of ...?	114
- What would you find in ...?	116
- Which is the odd word?.....	118
Level B - Input	
- What belongs in this group?.....	120
- What would you find in ...?	122
- What do you use for ...?.....	124
- What are parts of ...?	125
- Which is the odd word?.....	126
- Output	
- Think of a word in the same group.....	128
- Name words in this group	130
- Where:	
Name a place where you	
would find	133
In what shop would you find ...?	134
Level C - Input	
- What belongs in this group:	
8 choices	136
15 choices	138
- Find the group name	151
- What belongs in this group:	
Things described	159
Things and actions	161
Instructions and signs	163
- Who or what?	165
- Things or actions?	167
- Actions	173
- What belongs in this group:	
Telling where, when, how.....	174
- Arrange these words into ... groups.....	176
- Output	
- Think of more words in the same	
group	182
- Think of some words which belong	
in this group.....	184
- What is the name of this group?.....	188
- Name some parts of	191
- Think of action words	192
- Think of words that could describe	194
- Imagine you are in a shop:	
What do you need [for] ...?.....	196
Appendix: 'Everyday' Vocabulary	199

13

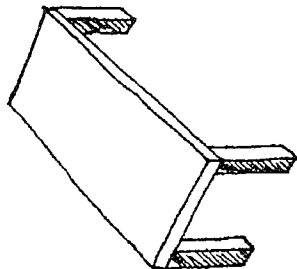
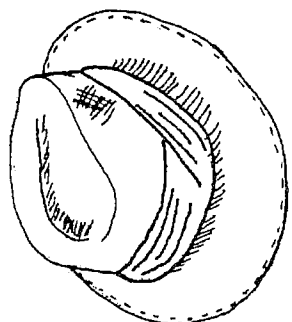
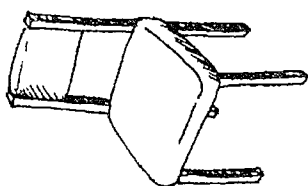
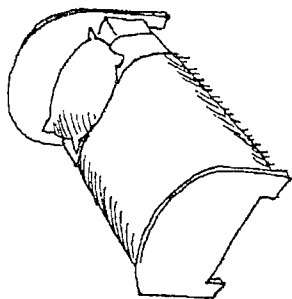

WHICH IS THE ODD ONE?

14

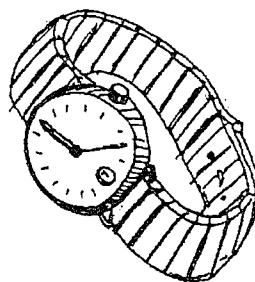
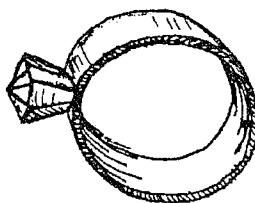
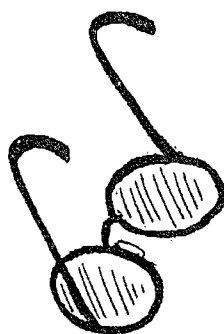
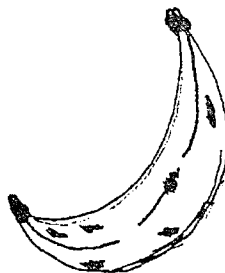

Word Meanings

Unrelated

Related

Vocabulary

Everyday

Specialized

Choices

4

Process

Input

Output

A

37

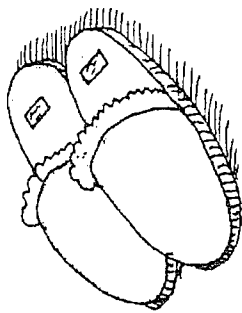
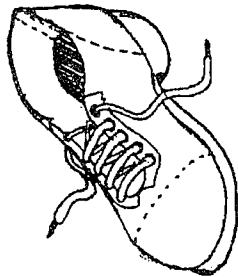
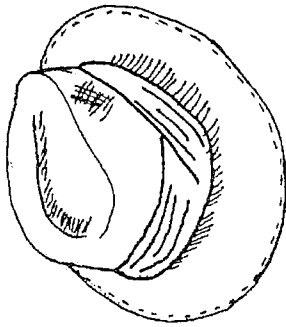
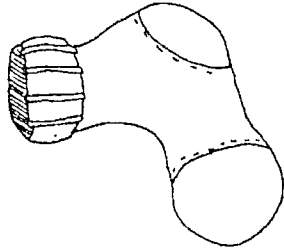

WHICH IS THE ODD ONE?

38

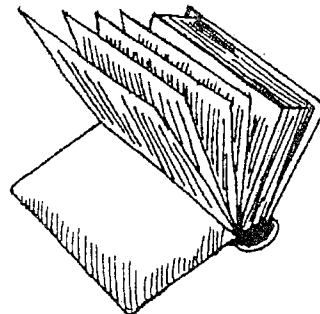
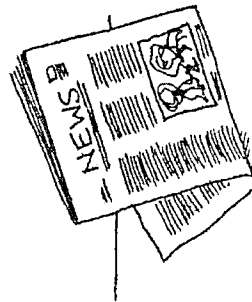
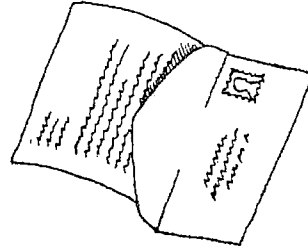

Word Meanings

Unrelated

Related

Vocabulary

Everyday

Specialized

Choices

4

Process

Input

Output

B

27

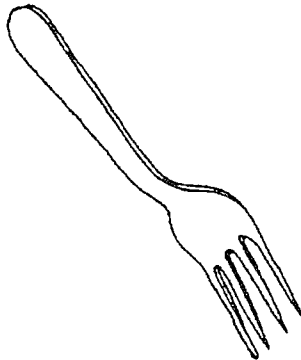
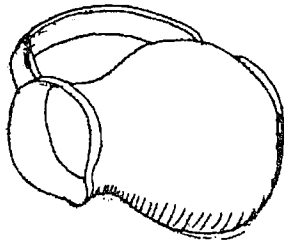
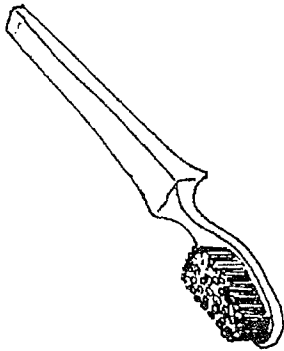
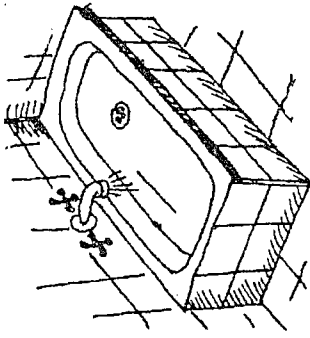

28

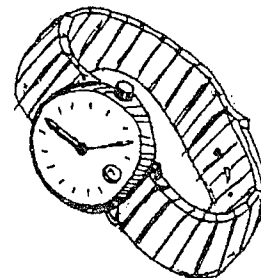
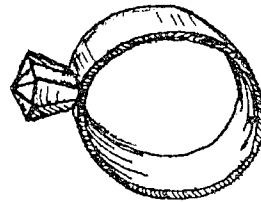
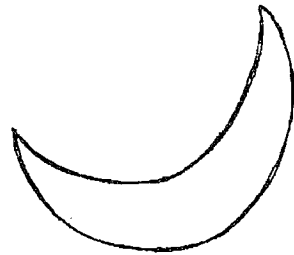
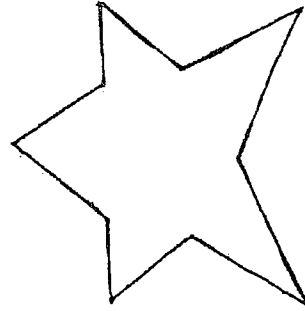

POINT TO THE ONE I SAY

Word Meanings

Unrelated

Related

Vocabulary

Everyday

Specialized

Choices

4

Process

Input

Output

B

POINT TO THE ONE I SAY

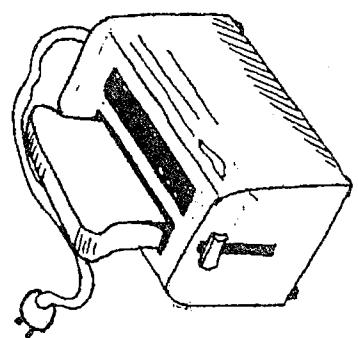
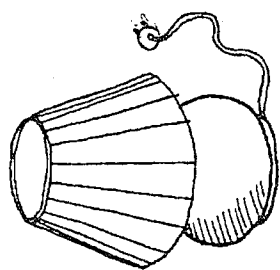
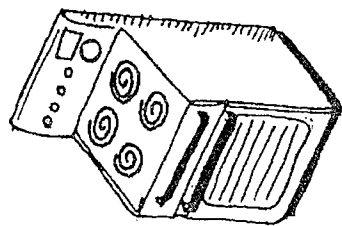
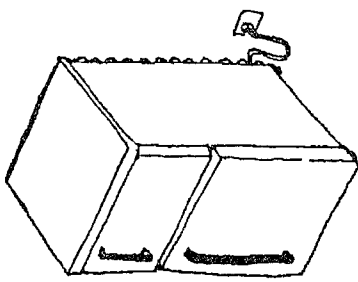
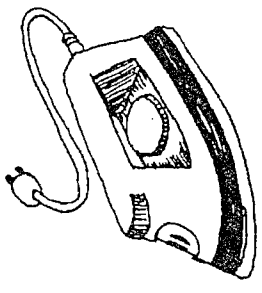
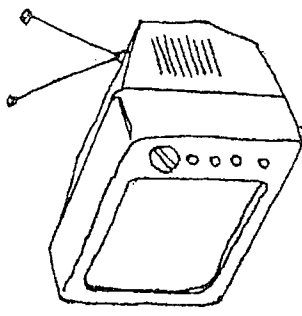

Word Meanings

- Unrelated
- Related

Vocabulary

- Everyday
- Specialized

Choices

6

Process

- Input
- Output

C

WHICH WORD MATCHES THE PICTURE?

69.

eye
nose
see

ear
mouth
look

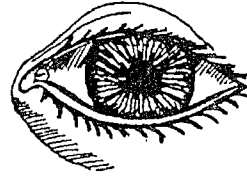

70.

candle
fire
cigarettes

light
matches
strike

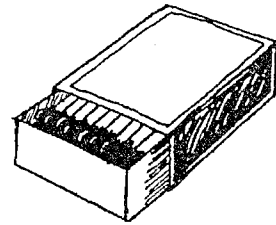

71.

door
shop
garage

house
windows
bank

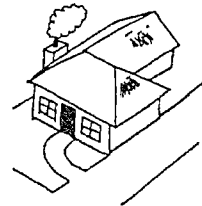

72.

bus
trailer
ambulance

train
truck
car

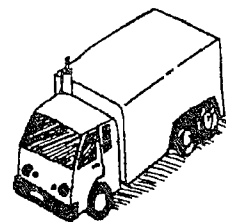

73.

shoe
foot
sock

lace
cotton
heel

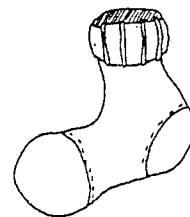

Word Meanings

Unrelated
Related

Vocabulary

Everyday
Specialized

Choices

6

Process

Input
Output

C

WHAT BELONGS IN THIS GROUP?

11. body parts desk, hand, foot, paper
12. furniture chair, nose, table, soap
13. boys' names William, Thomas, Robert, Sunday
14. months Rabbit, April, October, June
15. nuts peanut, book, vase, walnut
16. fruit floor, banana, apple, coat
17. tools hammer, bed, shoe, saw
18. money dollar, lemon, coin, rabbit
19. countries China, Window, Italy, Japan
20. musical instruments cat, piano, violin, trumpet

Word Meanings

Unrelated

Related

Vocabulary

Everyday

Specialized

Choices

4

Process

Input

Output

A

WHAT DO YOU USE FOR ...?

eg playing tennis

racquet, goalpost, hoop, ball

1. writing a letter

pen, paper, cheque book, pencil

2. baking a cake

flour, spatula, drill, beater

3. cleaning the floor

mop, toothbrush, broom, carpet

4. gardening

telephone, rake, nailfile, secateurs

5. cleaning the windows

ladder, vacuum cleaner, water, cloth

6. building a kennel

hammer, wood, nails, dog

7. painting a room

paint, brush, comb, ladder

8. going camping

tent, sleeping bag, racquet, life jacket

9. going fishing

ball, net, rod, bait

10. paying bills

cheque book, pen, envelope, camera

Word Meanings

Unrelated

Related

Vocabulary

Everyday

Specialized

Choices

Process

Input

Output

B

ARRANGE THESE WORDS INTO TWO GROUPS

pine
mahogany
tin
silver
nickel

iron
cedar
oak
gold
uranium

1. minerals

2. timbers

oranges
bakery
sausage
greengrocer's
cheese

bread
peaches
butcher's
delicatessen
steak

1. food

2. shops

Word Meanings

Unrelated

Related

Vocabulary

Everyday

Specialized

Choices

Process

Input

Output

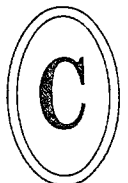

Books
Games Cards
Software Assessments



Silvereye
EDUCATIONAL PUBLICATIONS

for Special
Education and
Learning Difficulties

Ordering Information

You can order this and any other items:

- online at www.silvereye.com.au
- by phone to 02 8090 5395

Alternatively, you can complete the order form below and:

- fax to: 02 8003 9201
- mail to:
Silvereye Educational Publications,
67 Central Road, Avalon, NSW 2107

All prices include GST and are correct at time of publication.

Freight

We use couriers for deliveries to most Australian destinations. Deliveries to PO Boxes or remote destinations are by Australia Post. Most orders are delivered within 7-14 days or sooner.

Australian Freight Rates

Sydney area:

- \$7.95 for orders up to 5kg
- \$10.95 for orders over 5kg or large/ bulky items

Rest of Australia (all States and Territories)

- \$9.95 for orders up to 3kg
- \$11.95 for orders up to 5kg
- larger orders charged based on weight and destination

There is an additional \$2.50 registered post charge for orders over \$200 which are delivered by Australia Post.

New Zealand Freight Rates

Based on weight. For orders up to 3kg the cost is typically similar or lower than the freight cost within Australia.

Our mission is to positively impact the education of children and youth; particularly those with special needs and students at risk of school failure; by providing educators, counsellors, other professionals and parents with practical, theoretically sound and affordable products and service.

We provide books, games, cards, DVDs, assessment materials and other resources to assist with:

- *Special Education*
- *Behaviour*
- *Learning Difficulties*
- *Language & Communication*
- *Reading & Writing*
- *Guidance & Counselling*
- *Social Development*

ORDER FORM

QUANTITY	CODE	TITLE	AMOUNT

PURCHASER DETAILS

NAME	DATE
SCHOOL/ORGANISATION	
ADDRESS	
SUBURB	POSTCODE
TELEPHONE	FAX
EMAIL	

PAYMENT DETAILS

PAYMENT METHOD (please tick one)	CHEQUE <input type="checkbox"/> CREDIT CARD <input type="checkbox"/> INVOICE SCHOOL <input type="checkbox"/>	PURCHASE ORDER NUMBER (for school orders)
CARD NUMBER	EXPIRY DATE	
NAME ON CARD		
SIGNATURE		

Fax order to: **02 8003 9201** or mail to: Silvereye Educational Publications, 67 Central Road, Avalon, NSW 2107